

SPD

Surge Protective Device

SD25B Series



Description

SD25B is a type of surge protector using multi-layer graphite gap technology, 25kA inrush current (10/350 μ s) discharge level, to meet the highly exposed and frequent lightning strike areas of lightning defense requirements, suitable for all types of facilities at the main entrance to the power supply or the main switchboard cabinets for installation and use. The graphite gap technology makes the product's long-term performance independent of the environment where it is installed (e.g., high humidity, high salt, or highly polluted areas), making it ideal for use in harsh industrial environments.







Features

- High environment adaptability
- Telecommunication contact and failure indication function
- High throughput, low residual voltage, and strong continuity capability.
- Built-in over-temperature protection, safer failure protection
- Stable protection performance, no deterioration of the product after many lightning strikes.

Applications

- AC Power Supplies
- New Energy
- Residential Building
- Telecommunications
- Industrial Control

Agency Information

Agency Information		Standards	NO.	Category
	UL	EN 61643-11	R 50578598	Class II and Class I
	cUL	EN 61643-11	6113730.01AOC	Class II and Class I
	TUV	GB/T 18802.11	CQC23123376723	Class II and Class I
	CE	EN 61643-11	NL-83878	Class II and Class I
	KEMA	EN 61643-11	31-125675	Class II and Class I

Part Numbering System

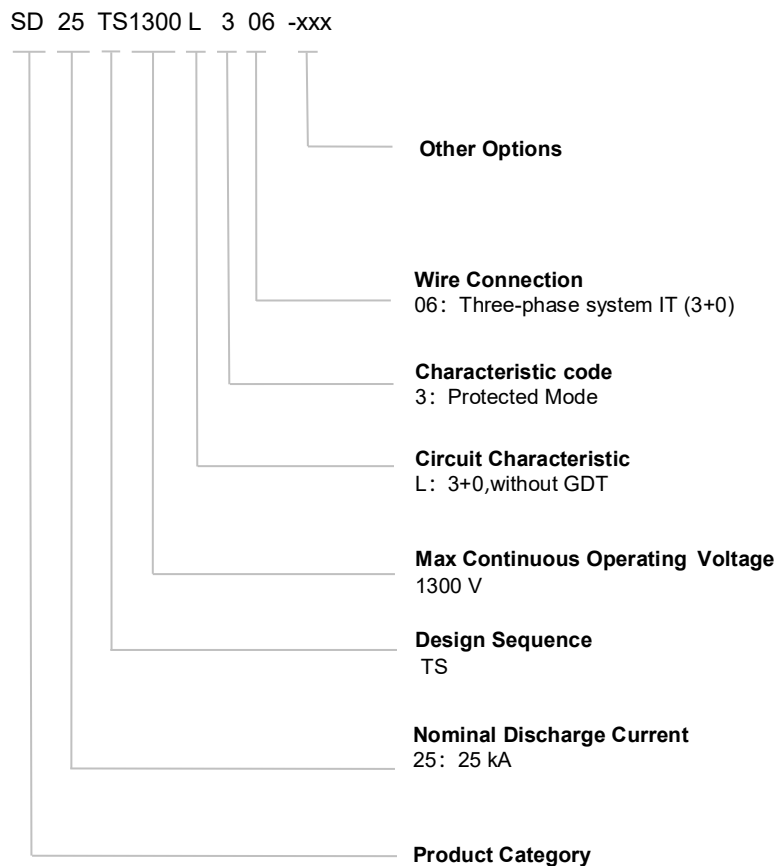

"●" indicates that the product has been certified, and "○" indicates that the product has not been certified.

SPD

Surge Protective Device

SD25B Series



Dimensions (mm)

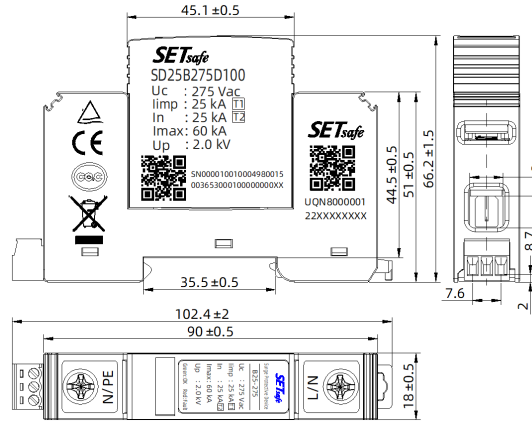

Schematics

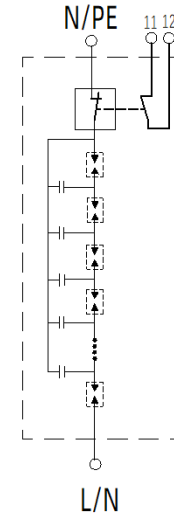

Features	Specifications
Model	SD25B275D100
Nominal System Voltage (U_n)	230 VAC
Maximum Continuous Operating Voltage (U_c)	275 VAC
Nominal Discharge Current (8/20 μ s) (I_n)	25 kA
Maximum Discharge Current (8/20 μ s) (I_{max})	60 kA
Class I Test Pulse Current (I_{imp})	25 kA
Voltage Protection Rating (U_p)	2.0 kV
Modes of Protection	L - N or N - PE
Follow current blocking capability (I_{fi})	6 kA @275 VAC
Max. Main-side Overcurrent Protection	315 A gL/gG
Short Current Rating (I_{SCCR})	6 kA
According to Standard	IEC/EN 61643-11, UL 1449 , GB/T 18802.11
Degrees of Protection of enclosure	IP20
Wiring Ability	(1.5 ~ 25) mm ² (Flexible) / 35 mm ² (Rigid)
Installation	35 mm DIN rail
Alarm	Remote + Indicator
Operating State / Fault Indication	Green (OK) / Red (Fault)
Remote Indication Contacts	AC: 250 V / 0.5 A, DC: 250 V / 0.1 A
Altitude	- 500 ~ 5000 m
Operational Temperature Range	(-40 ~ 125) °C



Dimensions (mm)

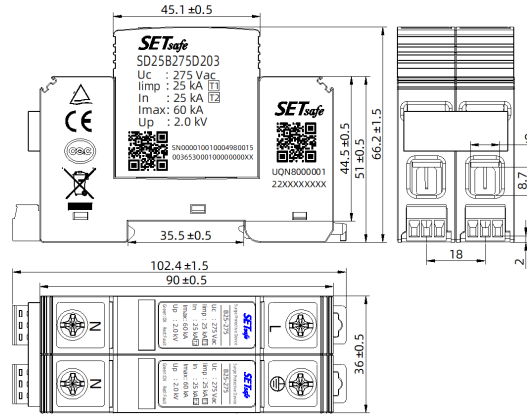

Schematics

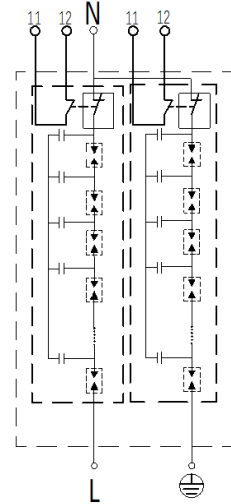

Features	Specifications
Model	SD25B275D203
Nominal System Voltage (U_n)	230 VAC
Maximum Continuous Operating Voltage (U_c)	275 VAC
Nominal Discharge Current (8/20 μ s) (I_n)	25 kA
Maximum Discharge Current (8/20 μ s) (I_{max})	60 kA
Class I Test Pulse Current (I_{imp})	25 kA
Voltage Protection Rating (U_p)	2.0 kV
Modes of Protection	L - N , N - PE
Follow current blocking capability (I_{fi})	6 kA @275 VAC
Max. Main-side Overcurrent Protection	315 A gL/gG
Short Current Rating (I_{SCCR})	6 kA
According to Standard	IEC/EN 61643-11, UL 1449 , GB/T 18802.11
Degrees of Protection of enclosure	IP20
Wiring Ability	(1.5 ~ 25) mm ² (Flexible) / 35 mm ² (Rigid)
Installation	35 mm DIN rail
Alarm	Remote + Indicator
Operating State / Fault Indication	Green (OK) / Red (Fault)
Remote Indication Contacts	AC: 250 V / 0.5 A, DC: 250 V / 0.1 A
Altitude	- 500 ~ 5000 m
Operational Temperature Range	(-40 ~ 125) °C



Dimensions (mm)

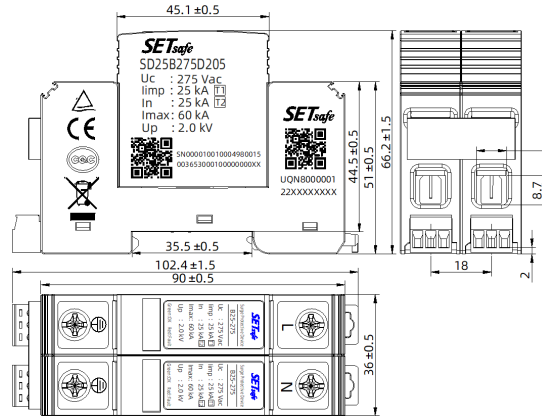

Schematics

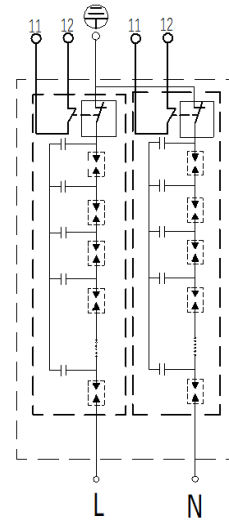

Features	Specifications
Model	SD25B275D205
Nominal System Voltage (U_n)	230 VAC
Maximum Continuous Operating Voltage (U_c)	275 VAC
Nominal Discharge Current (8/20 μ s) (I_n)	25 kA
Maximum Discharge Current (8/20 μ s) (I_{max})	60 kA
Class I Test Pulse Current (I_{imp})	25 kA
Voltage Protection Rating (U_p)	2.0 kV
Modes of Protection	L - PE , N - PE
Follow current blocking capability (I_{fi})	6 kA @275 VAC
Max. Main-side Overcurrent Protection	315 A gL/gG
Short Current Rating (I_{SCCR})	6 kA
According to Standard	IEC/EN 61643-11, UL 1449 , GB/T 18802.11
Degrees of Protection of enclosure	IP20
Wiring Ability	(1.5 ~ 25) mm ² (Flexible) / 35 mm ² (Rigid)
Installation	35 mm DIN rail
Alarm	Remote + Indicator
Operating State / Fault Indication	Green (OK) / Red (Fault)
Remote Indication Contacts	AC: 250 V / 0.5 A, DC: 250 V / 0.1 A
Altitude	- 500 ~ 5000 m
Operational Temperature Range	(-40 ~ 125) °C

SPD

Surge Protective Device

SD25B Series



Dimensions (mm)

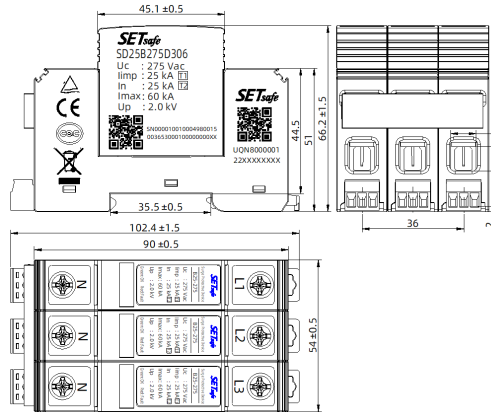

Schematics

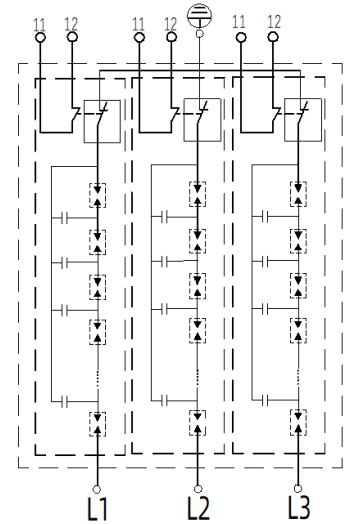

Features	Specifications
Model	SD25B275D306
Nominal System Voltage (U_n)	230 VAC
Maximum Continuous Operating Voltage (U_c)	275 VAC
Nominal Discharge Current (8/20 μ s) (I_n)	25 kA
Maximum Discharge Current (8/20 μ s) (I_{max})	60 kA
Class I Test Pulse Current (I_{imp})	25 kA
Voltage Protection Rating (U_p)	2.0 kV
Modes of Protection	L - PE
Follow current blocking capability (I_{fi})	6 kA @275 VAC
Max. Main-side Overcurrent Protection	315 A gL/gG
Short Current Rating (I_{SCCR})	6 kA
According to Standard	IEC/EN 61643-11, UL 1449, GB/T 18802.11
Degrees of Protection of enclosure	IP20
Wiring Ability	(1.5 ~ 25) mm ² (Flexible) / 35 mm ² (Rigid)
Installation	35 mm DIN rail
Alarm	Remote + Indicator
Operating State / Fault Indication	Green (OK) / Red (Fault)
Remote Indication Contacts	AC: 250 V / 0.5 A, DC: 250 V / 0.1 A
Altitude	- 500 ~ 5000 m
Operational Temperature Range	(-40 ~ 125) °C

SPD

Surge Protective Device

SD25B Series

Dimensions (mm)

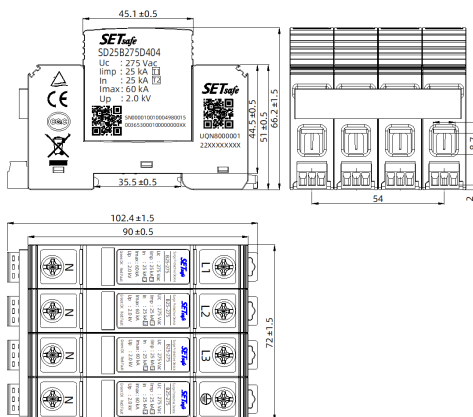

Schematics

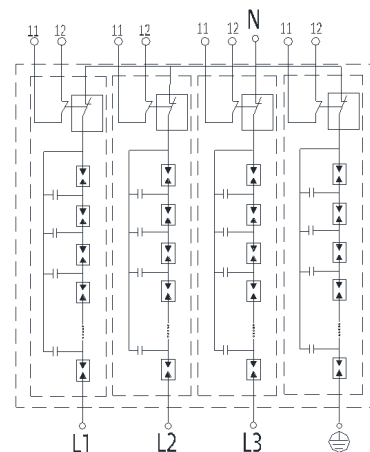

Features	Specifications
Model	SD25B275D404
Nominal System Voltage (U_n)	230 VAC
Maximum Continuous Operating Voltage (U_c)	275 VAC
Nominal Discharge Current (8/20 μ s) (I_n)	25 kA
Maximum Discharge Current (8/20 μ s) (I_{max})	60 kA
Class I Test Pulse Current (I_{imp})	25 kA
Voltage Protection Rating (U_p)	2.0 kV
Modes of Protection	L - N , N - PE
Follow current blocking capability (I_{fi})	6 kA @275 VAC
Max. Main-side Overcurrent Protection	315 A gL/gG
Short Current Rating (I_{SCCR})	6 kA
According to Standard	IEC/EN 61643-11, UL 1449 , GB/T 18802.11
Degrees of Protection of enclosure	IP20
Wiring Ability	(1.5 ~ 25) mm ² (Flexible) / 35 mm ² (Rigid)
Installation	35 mm DIN rail
Alarm	Remote + Indicator
Operating State / Fault Indication	Green (OK) / Red (Fault)
Remote Indication Contacts	AC: 250 V / 0.5 A, DC: 250 V / 0.1 A
Altitude	- 500 ~ 5000 m
Operational Temperature Range	(-40 ~ 125) °C

SPD

Surge Protective Device

SD25B Series



Dimensions (mm)

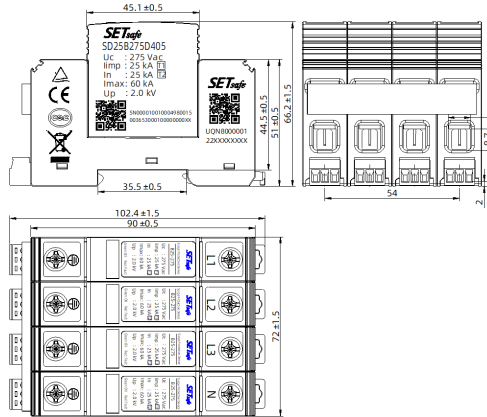

Schematics

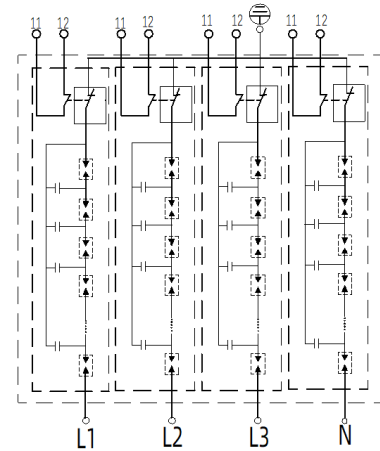

Features	Specifications
Model	SD25B275D405
Nominal System Voltage (U_n)	230 VAC
Maximum Continuous Operating Voltage (U_c)	275 VAC
Nominal Discharge Current (8/20 μ s) (I_n)	25 kA
Maximum Discharge Current (8/20 μ s) (I_{max})	60 kA
Class I Test Pulse Current (I_{imp})	25 kA
Voltage Protection Rating (U_p)	2.0 kV
Modes of Protection	L - PE , N - PE
Follow current blocking capability (I_{fi})	6 kA @275 VAC
Max. Main-side Overcurrent Protection	315 A gL/gG
Short Current Rating (I_{SCCR})	6 kA
According to Standard	IEC/EN 61643-11, UL 1449 , GB/T 18802.11
Degrees of Protection of enclosure	IP20
Wiring Ability	(1.5 ~ 25) mm ² (Flexible) / 35 mm ² (Rigid)
Installation	35 mm DIN rail
Alarm	Remote + Indicator
Operating State / Fault Indication	Green (OK) / Red (Fault)
Remote Indication Contacts	AC: 250 V / 0.5 A, DC: 250 V / 0.1 A
Altitude	- 500 ~ 5000 m
Operational Temperature Range	(-40 ~ 125) °C

Wiring Diagram

Single phase system

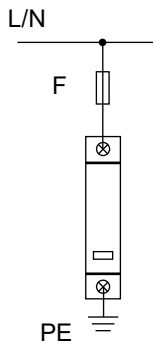

"1+0"
Connection

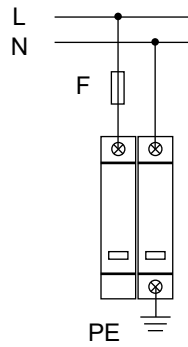

"2+0"
Connection

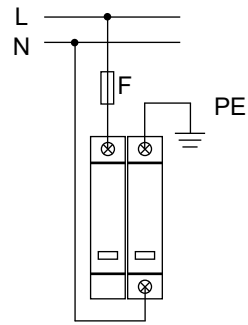

"1+1"
Connection

Three phase system

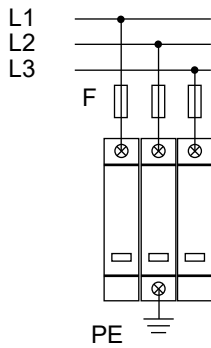

"3+0"
Connection

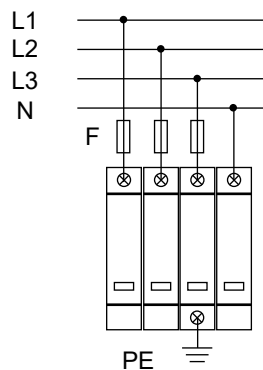

"4+0"
Connection

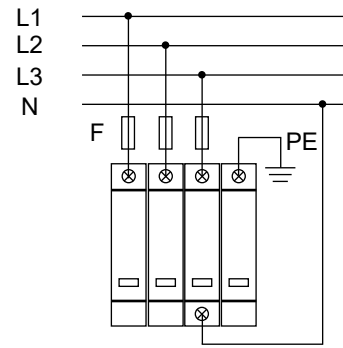

"3+1"
Connection

Connection of SPD in networks

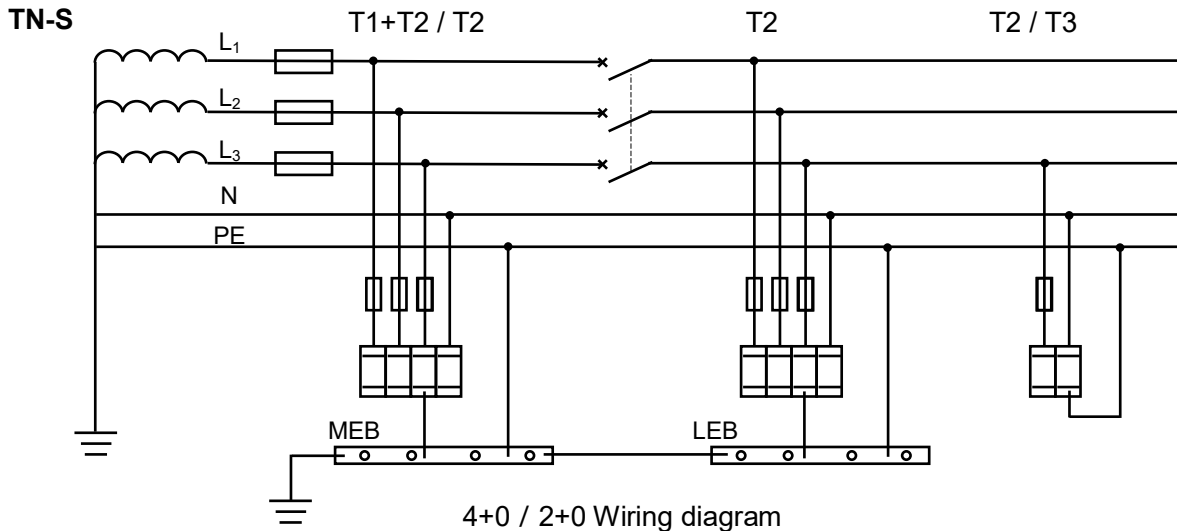

4+0 / 2+0 Wiring diagram

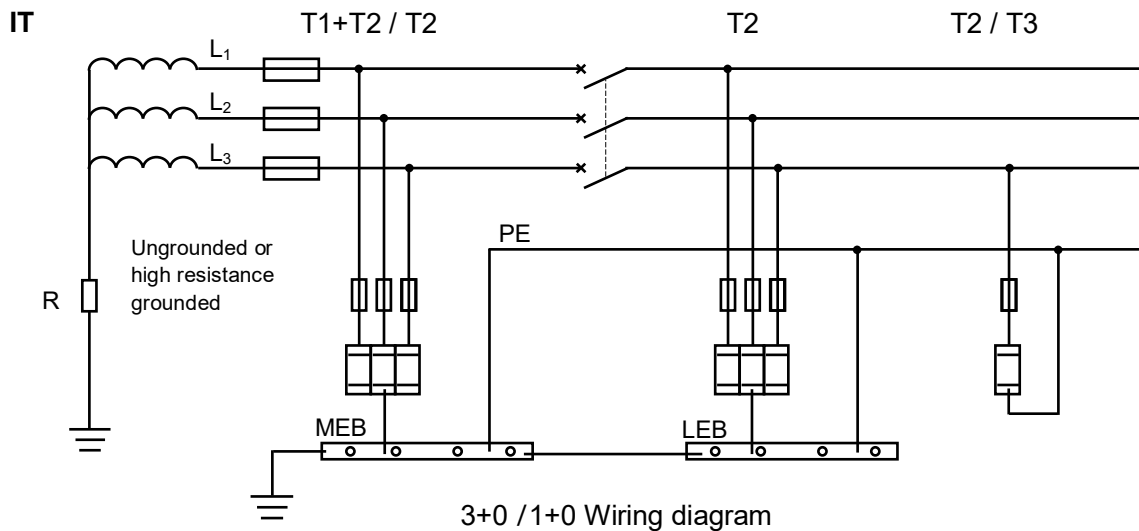
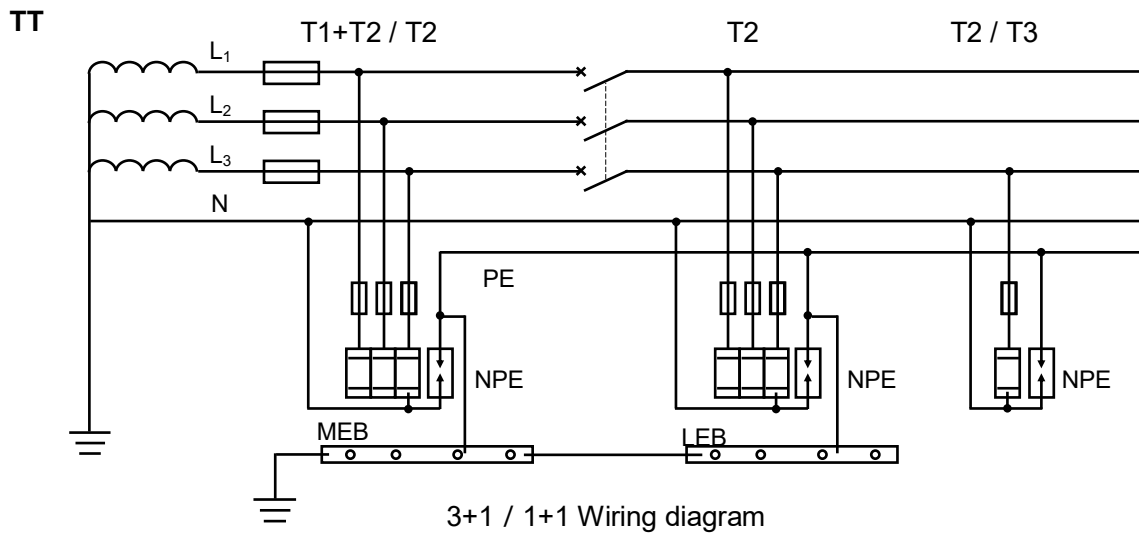
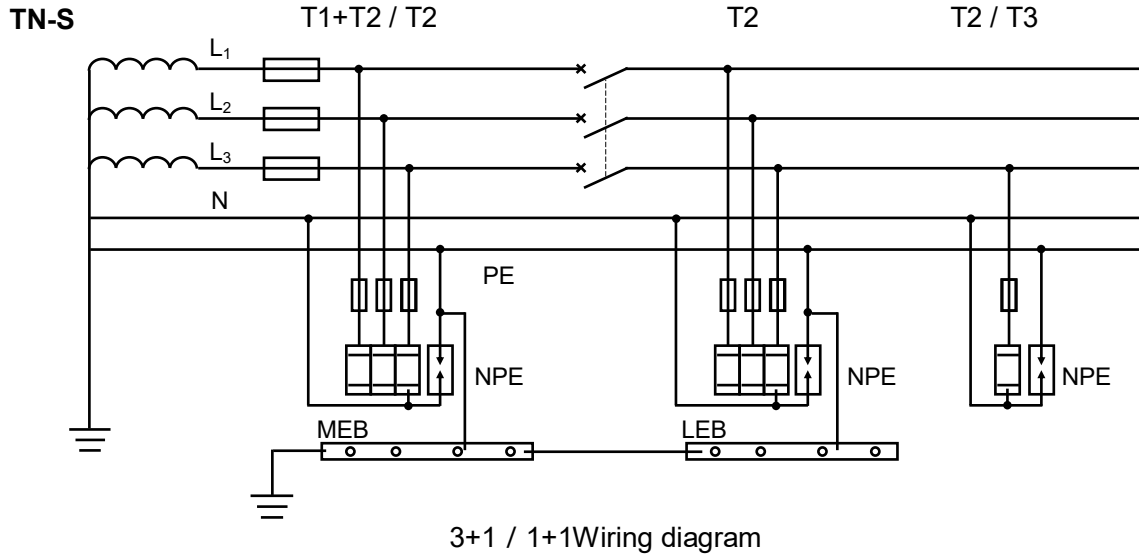

Overvoltage

Electricity is an essential part of modern human production and life. But power facilities are threatened by internal and external overvoltages. Power system overvoltage mainly includes:

Transient overvoltage of atmospheric origin: Lightning strikes instantly generate high energy, generating surge currents up to hundreds of kA, and lightning wave can invade along power lines, causing damage to power facilities and electrical equipment

Transient overvoltage due to switching: Switching operations of a power utility may cause overvoltage.

Temporary overvoltage: A long duration (second level) temporary overvoltage (asymmetric ground fault) or harmonious overvoltage.

Surge Voltage Caused by Lightning

Electrical and electronic system are subject to damage from a lightning electromagnetic impulse (LEMP). Therefore SPM need to be provided avoid failure of internal system. LEMP may caused by direct, near and far lightning strikes. According to the relevant research, lightning strikes within a certain distance may cause dangerous overvoltage on the cable, endangering the equipment connected to it.

Damage Due to Lighting

The lighting can cause three basic type of damage:

- D1: injury to living beings by electric shock;
- D2: physical damage (fire, explosion, mechanical destruction, chemical release) due to lighting current effects, including sparking;
- D3: failure of internal systems due to LEMP

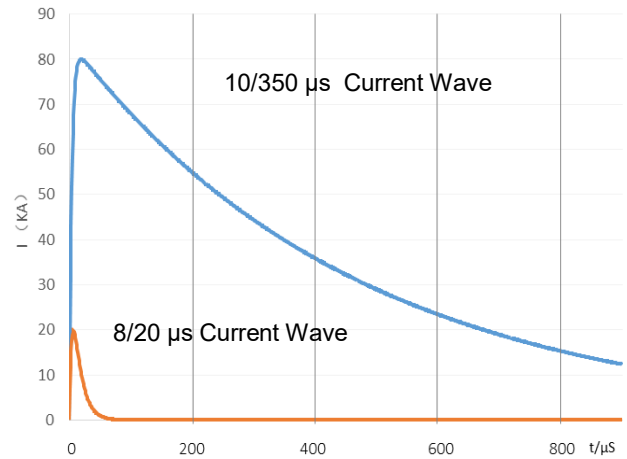

Standard lightning test wave

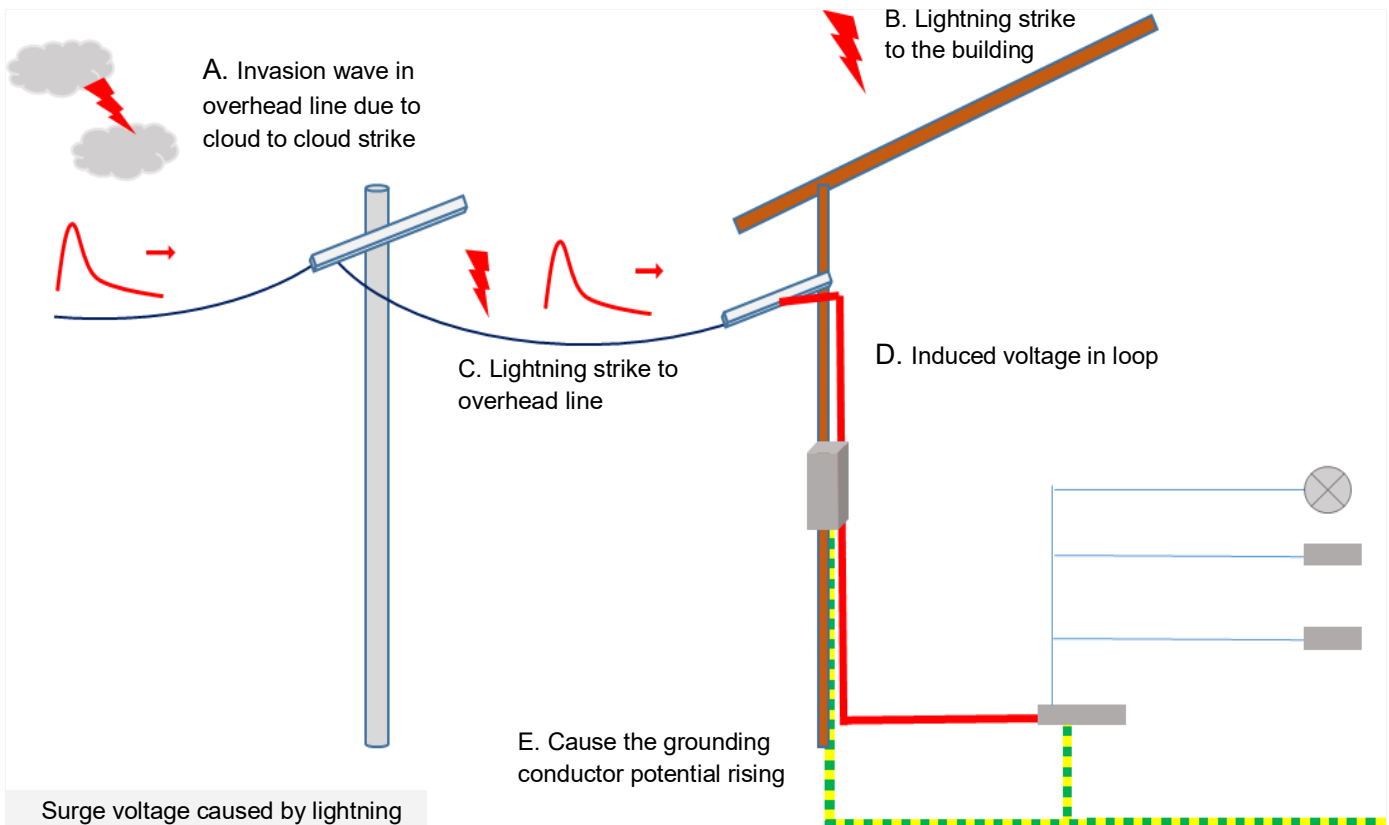

Surge voltage caused by lightning

Impulse Withstand Voltage and Surge Protection

As the primary equipment of internal lightning-proof, SPD needs to be able to withstand surge stress and provides the level of voltage protection required for the equipment. This involves the selection and coordination of SPD in different locations to form a complete protection system.

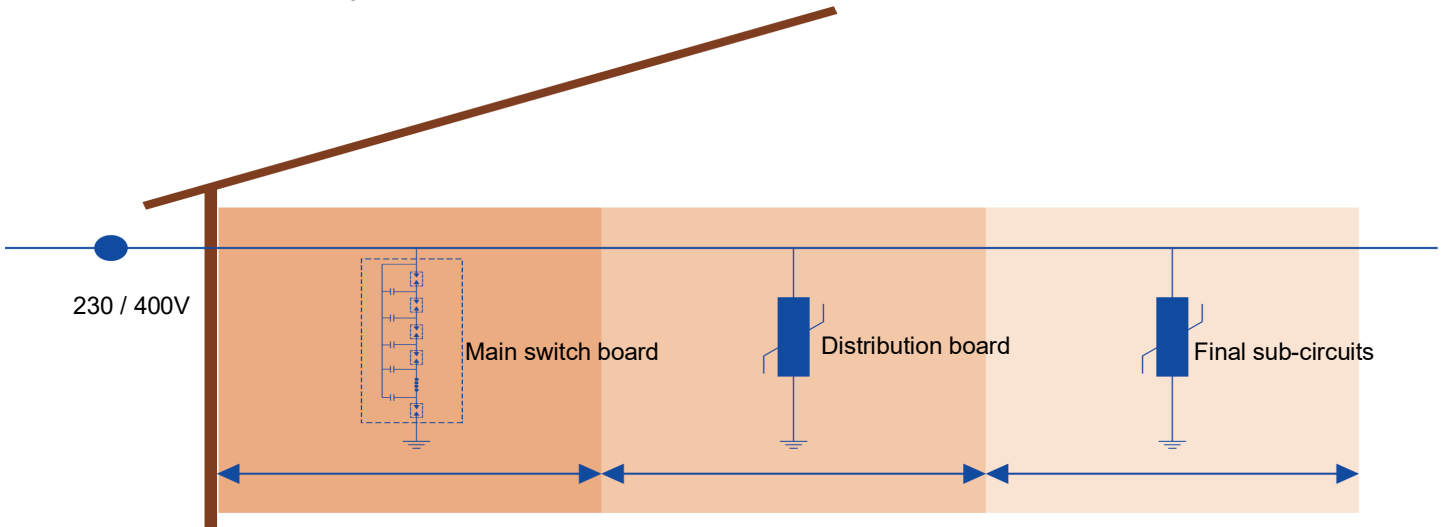
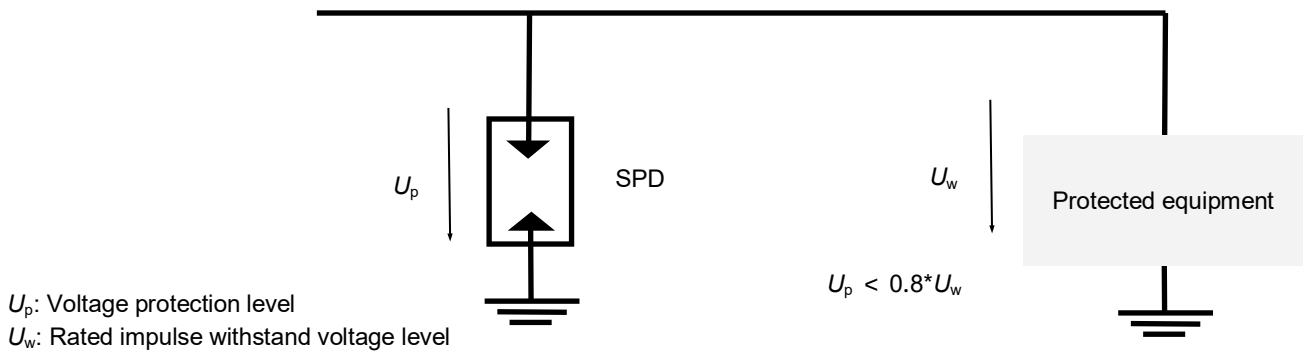
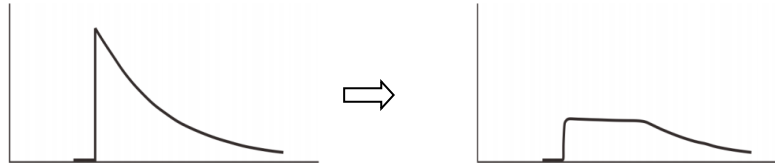

Overvoltage Category	IV	III	II	I
U_w (kV) Impulse Withstand Voltage	6	4	2.5	1.5
Lightning Protection Zone LPZ	LPZ1	LPZ2	LPZn	
SPD Type	Class I or Class II	Class II	Class II or Class III	

Patents

Name	Region	Category	Patent NO.
An assembly structure of graphite sheet and a multi-gap surge protector	China	Utility Model	ZL2020224794329
A graphite surge protector	China	Utility Model	ZL2021200420130
Graphite Electrodes for Surge Protectors	China	Patent for Invention	ZL2015107765687
Graphite Electrodes for Surge Protectors	China	Utility Model	ZL2015209014118
Graphite Electrodes for Surge Protectors	China	Patent for Invention	ZL201720468784X

Glossary

Item	Description
U_p	Voltage Protection Level Maximum voltage to be expected at the SPD terminals due to an impulse stress with defined voltage steepness and an impulse stress with a discharge current with given amplitude and wave shape.
8/20 μ s	8/20 Current Impulse Current impulse with a nominal virtual front time of 8 μ s and a nominal time to half-value of 20 μ s.
1.2/50 μ s	1.2/50 Voltage Impulse Voltage impulse with a nominal virtual front time of 1.2 μ s and a nominal time to half-value of 50 μ s.
U_c	Maximum Continuous Operating Voltage Maximum r.m.s. voltage, which may be continuously applied to the SPD's mode of protection. — (IEC 61643-11)
I_n	Nominal Discharge Current Crest value of the current through the SPD having a current waveshape of 8/20 μ s. — (IEC 61643-11)
I_{imp}	Impulse Discharge Current for Class I Test Crest value of a discharge current through the SPD with specified charge transfer Q and specified energy W/R in the specified time. — (IEC 61643-11)
I_{max}	Maximum Discharge Current Crest value of a current through the SPD having an 8/20 μ s waveshape and magnitude according to the manufacturers specification. I_{max} is equal to or greater than I_n .
Modes of Protection	Modes of Protection An intended current path, between terminals that contains protective components, e.g. line-to-line, line-to-earth, line-to-neutral, neutral-to-earth.
IP	Degrees of Protection of enclosure Classification preceded by the symbol IP indicating the extent of protection provided by an enclosure against access to hazardous parts, against ingress of solid foreign objects and possibly harmful ingress of water. — (IEC 60529)



ATTENTION

Usage

1. The voltage applied continuously to the SPD must not exceed its maximum continuous operating voltage U_c .
2. When atmosphere press is from 54 kPa to 106 kPa, the related altitude shall be from 5000 m to - 500 m.
3. Do not touch the product body or wires directly when power is on, to avoid electric shock.

Replacement

As SPD is a non-repairable product, for safety sake, please use the same type of SPD for replacement.

Storage

Do not store SPD at high temperature, high humidity or corrosive gas environment. Use them up within 2 years after receiving the goods.

Installation

1. Installation and startup may only be carried out by qualified personnel. The relevant country-specific regulations must be observed.
2. Check the device for external damage before installation. If the device is defective, it must not be used.
3. Pay attention to risk of electric shock. Please cutoff all electrical power before installation or service.
4. Lay the output cables to the surge protective devices (SPDs) as short as possible, without loops.
5. Please install proper backup protection devices in front of SPD.
6. Do not apply mechanical stress to the SPD body during or after the installation.

Maintenance

1. Check SPD status according to instructions before and after the thunderstorm season each year.
2. If the indicator of "failure state" appears, the SPD is damaged. Replace the SPD with same type.
3. Ensure electrical connections and mountings are correct before energizing the circuit.
4. SPD's quality is well controlled and strictly inspected before delivery. If non-functional ones are found during operation, please contact us early enough.